



Cite this: *Green Chem.*, 2023, **25**, 5501

The environmental impact and economic feasibility assessment of composite calcium alginate bioplastics derived from *Sargassum*[†]

Akeem Mohammed,^a Keeran Ward,^b *^b Koon-Yang Lee *^c and Valerie Dupont^b

For much of the Caribbean region, plastic pollution and the persistence of the great Atlantic *Sargassum* belt lead to significant regional loss in biodiversity, employment and tourism. Yet, seaweeds such as *Sargassum* possess all the characteristics for bioplastic production. This study presents a new process on the production of biodegradable calcium alginate (Ca(Alg)₂) composite bioplastic, and evaluates its economic feasibility and environmental impact in the Caribbean, compared to bio-based polylactic acid (PLA) and synthetic plastics (PET). Our cradle-to-gate life cycle impact assessment (LCIA) shows normalized (kg CO₂eq per kg plastic) greenhouse gas (GHG) impacts 3 to 7 times higher for the baseline alginate composite process over those of PLA and PET films – linked mainly to chemical consumption. However, through the integration of abundant bioenergy from the local paper industry and the nascent E-methanol (E-MeOH) supply chains, GHG impact reduces by 79% – illustrating a pathway to a sustainable bioplastic production flowsheet. More attractively, the alginate bioplastic outperforms in providing ultra-low oxygen barrier packaging properties – with a required mass of plastic material producing a total carbon footprint (kg CO₂eq) 64–978 times lower than PLA and PET respectively, and overall packaging costs 280 times less than current synthetic plastic. Techno-economics illustrate that a total annualized cost (TAC) for alginate bioplastic of \$US 4.56 per kg is possible, ensuring high economic feasibility, comparable to current commercial bio-based alternatives. Moreover, sensitivity analysis highlights that variability in TAC was mainly associated with sodium alginate utilization in the manufacture process – contributing up to 67% to the overall cost. In light of this, the integration of sound policies aligned to improved consumer awareness and reduced plastic waste can help to drive greater economic feasibility of the alginate bioplastic industry. Ultimately, our study illustrates a viable and sustainable alginate bioplastic alternative, promoting and informing on packaging innovation while achieving low carbon operations within the Caribbean plastic sector.

Received 29th March 2023,
Accepted 9th June 2023

DOI: 10.1039/d3gc01019h

rsc.li/greenchem

1. Introduction

Synthetic petroleum-based plastics have been widely used owing to their low cost, light weight, and durability, contributing greatly to everyday activities.¹ Thus, the plastics industry is anticipated to expand, with global production of the material likely to reach 1.63 billion tons by 2050.² However, the majority of these plastics are single use packaging and eventually

accumulate in the natural environment, breaking down into microplastics resulting in severe health concerns.³

Additionally, plastic production emits approximately 390 million tons (Mt) of greenhouse gas (GHG) emissions per year – directly linked to fossil fuel consumption, used as both feedstock and energy within the process.⁴ The two aforementioned problems have been critical driving forces for the development of alternative bio-based materials. Bio-based plastics are currently being developed to replace traditional petroleum plastics as these materials are natural carbon sinks – absorbing CO₂ from the atmosphere and emitting up to 30% less GHG emissions,⁵ while decomposing much faster in the natural environment over synthetic plastics *via* aerobic degradation or anaerobic fermentation.^{6–8}

In comparison to fossil-based plastics, bio-based polymers make up a relatively minor portion of the market. Bioplastics make up less than 1% of the yearly 390 Mt of plastic generated. Global bioplastics production capacity is expected to rise from

^aDepartment of Chemical Engineering, University of the West Indies, St Augustine, Trinidad and Tobago

^bSchool of Chemical and Process Engineering (SCAPE), University of Leeds, Leeds, LS2 9JT, UK. E-mail: k.r.ward@leeds.ac.uk

^cDepartment of Aeronautics and Institute for Molecular Science and Engineering, Imperial College London, South Kensington Campus, SW7 2AZ London, UK.

E-mail: koonyang.lee@imperial.ac.uk

[†]Electronic supplementary information (ESI) available. See DOI: <https://doi.org/10.1039/d3gc01019h>



around 2.2 Mt in 2022 to nearly 6.3 Mt in 2027.⁹ Bioplastics are highly versatile and widely used in many industries with diverse applications. Some current novel strategies include programmable biopolymer nanoparticles in pharmaceuticals,¹⁰ green electrospinning of biopolymer nanofibers in drug delivery systems, tissue engineering, air filtration, and affinity membrane systems,¹¹ and preparation of sustainable organic nanocomposite ionogel electrolytes using biopolymers for flexible energy storage.¹²

In 2022, global production capacities of bioplastics amounted to about 2.22 Mt with 48% (1.07 Mt) of the volume destined for the packaging market – the biggest market segment within the bioplastics industry.⁹ PLA and PHA are the most widely used, high technology readiness level, commercial biodegradable bioplastics, and constitute the highest percentages for the global production capacity of emerging bioplastics and expected to increase in market share of 37.9% and 8.9% respectively by 2027.⁹ Further to this, PLA and PET are the major competitors for the alginate bioplastic in the food packaging industry.

Modern packaging methods and materials are highly advanced and adaptable to individual applications and demands. The specifications for food packaging are varied and extensive. There is a high demand for packaging made from bioplastics to be used for food packaging with particular requirements including low oxygen barrier which has been found to be a major limitation restricting the use of bioplastics in food applications.¹³ During 2022–2023, the barrier packaging market is anticipated to grow at a CAGR of 5.5%. By 2032, the market is anticipated to reach a value of US\$10.7 billion.¹⁴ Due to consumer demand for higher performing gas barriers that enhance product shelf-life and maintains quality, the oxygen and gas barrier film market, is anticipated to grow 4.1% annually.¹⁵

Thus, the growth of the bioplastics industry is vital and highly dependent on government regulations and public awareness. Therefore, its development and commercialization is timely and necessary in promoting a more sustainable plastic industry. Seaweeds have been shown to be successful raw materials for the formation of bioplastics.^{16,17} Within the Caribbean region, *Sargassum natans* (*S. natans*) brown seaweeds have been disrupting livelihoods aligned to tourism and fishery resources for the past decade.¹⁸ Our own past studies have shown that sodium alginate (NaAlg) can be successfully extracted from this invasive seaweed^{19,20} and used to fabricate compostable calcium alginate, Ca(Alg)₂, bioplastics possessing comparable properties to those of synthetic and bio-based plastic alternatives, including good degradation under 14 days by depolymerisation in simulated aerobic conditions at 58 °C.²¹

Alginate bioplastics are produced from renewable, plant-based resources and brown seaweed which makes use of the blue economy.²² Additionally, brown seaweeds are easily cultivated in natural environments without fertilizer use, do not compete with food sources, can be harvested naturally, are able to grow in a wide range of environments, present no risk

to potential deforestation, and are active carbon sinks.^{23,24} In addition, *Sargassum* is inedible owing to its high levels of total arsenic and other heavy metal ions such as copper, molybdenum, and manganese²⁵ and does not compete as a food resource thereby proving to be a good supply chain for bioplastic production. At the end of the product life cycle, this bioplastic can be organically recycled *via* industrial composting, creating natural fertilizers. Its increased adoption and use will help meet climate targets and reduce plastic waste mismanagement.

Ultimately, in promoting economic sustainability within a developing bioplastic industry, technical feasibility needs to be addressed. Techno-economic analysis (TEA) is a useful tool for evaluating the economic feasibility of industrial processes. TEA has been successfully carried out on bioplastics from various biopolymer sources such as polyhydroxyalkanoates (PHA),^{26,27} polylactic acid (PLA),^{28,29} PLA composites,³⁰ and 2,5-furan dicarboxylic acid.^{31,32} Thus, TEA further allows for direct comparison of the alginate bioplastic cost to other fossil and bio-based plastics-illustrating areas where economic viability can be improved.

In addition to TEA, environmental quality needs to be ensured for any novel process. Life cycle assessment (LCA) is a promising tool for measuring the environmental impact of materials and products. It has been widely utilized to compare bio-based and fossil-based plastics such as PLA,³³ PHB,³⁴ bio-based high density polyethylene (HDPE),³⁵ and bio-derived polyethylene.³⁶

Our study considers the radical redesign of traditional plastics, through the intervention of a purely bio-based composite framework coupled with TEA and LCA tools to assess the economic and environmental sustainability of novel calcium–alginate composites. Currently, alginate bioplastics are at a low technology readiness level (TRL) and at the beginning of the maturity/optimization curve. Therefore, this study presents a preliminary assessment on the future development of an alginate bioplastic industry. Furthermore, this paradigm shift towards the utilization of natural, bio-based raw materials within plastic production illustrates solutions to the on-going *Sargassum* crisis in the Caribbean, while advocating for new policies in plastic packaging, which incentivizes a sustainable plastic sector across the region.

2. Methodology

2.1 Geographic relevance and motivation

Since 2011, the Caribbean, has seen unprecedented migration of *Sargassum* onto its shores. *Sargassum*, fueled by high nutrient run-off, sunlight, and climate change, originates in the Atlantic Ocean where enormous mats are carried by ocean currents to and through the Caribbean.³⁷ In June 2022, more than 24 Mt of *Sargassum* covered the Atlantic, breaking the previous record set in May 2018 by 20%.³⁸ This tremendous influx negatively affects fisher livelihoods, biodiversity and tourism, while decomposition of the



seaweed releases toxic hydrogen sulphide and ammonia gas.^{39–41} National economies in the Caribbean region, climate sensitive sectors, and coastal livelihoods have been severely harmed by these occurrences. It is currently thought that this new *Sargassum* crisis, which was brought on by a mix of ocean eutrophication and climate change, is the “new norm”,⁴² and Caribbean countries must find methods to adapt. Consequently, there has been a growing demand for finding useful strategies and technologies to utilize this *Sargassum* as a raw material in new valorization applications, converting this waste feedstock into an opportunity. This study forms a unique case study, whereby the development of a novel *Sargassum* inspired, bioplastic industry can be formed within the Caribbean region.

Trinidad and Tobago has a high GDP despite being a small island developing state, owing to the country's vast resources, including its oil and gas deposits, petrochemical industry (methanol and ammonia), and downstream hydrocarbon sectors.⁴³ Trinidad is one of the most industrially developed islands in the Caribbean and thus holds significant promise to the establishment of a novel alginate bioplastic industry due to its relevance to global markets, strong energy industry that can link directly to this process, strong supply chains, easy access to resources, and high levels of expertise. As a member of the 16 million-strong Caribbean community, Trinidad and Tobago has potential to develop this industry through unique partnerships with other lesser industrialized islands, also significantly affected by the *Sargassum* migration, to progress a biomass supply chain that will enable bioplastic productivity.

Furthermore, Trinidad and Tobago, a small consumer, has no influence over packaging choices made in larger economies where plastic products are produced and imported. It is estimated that 48% of the plastic waste dumped in Trinidad and Tobago's landfills comes from plastic packaging for imported goods rather than from plastic waste generated for domestic use.⁴⁴

The management of plastics is locally problematic, promoted by landfill age and overuse as well as improper disposal.⁴⁵ Plastics accounted for 19% (89 461 MT) of municipal solid waste in the landfills in 2010⁴⁶ – growing significantly (8% in 2016) due to the lack of recycling initiatives and incentives by governments.⁴⁴ Plastic packaging accounted for 54.8% of the plastic waste, with PET and LDPE as major contributors – 27% and 47.6% respectively.⁴⁴ Therefore, the drive for packaging innovation is fundamental and timely. In light of this, a novel calcium alginate bioplastic process aims to address both problems, by providing a valorization pathway for *Sargassum* biomass while also fostering innovation in bio-based biodegradable packaging solutions.

By establishing this bioplastic sector in Trinidad and Tobago, the Caribbean region can benefit greatly from the transfer of technological information, techniques and skills, and guidance on new policies which can accelerate bioplastic adoption. Ultimately, this study seeks to provide evidence-based guidance in sustainable packaging to primary stake-

holders locally, regionally, and internationally, informing on the sustainable operations of the packaging industry.

2.2 Process description

The modeling framework derived for this study considers the techno-economic and environmental assessment of the conceptual process design for the production of Ca(Alg)₂ bioplastics derived from locally obtained *Sargassum natans* seaweed is illustrated in Fig. 1. Mass and energy balances were carried out utilizing experimentally determined process conditions (Mohammed *et al.*, 2020),²⁰ together with available process literature^{47–50} (ESI-Section 1.1†) and thermodynamic properties from Aspen Plus V10. All processes were designed to generate 1000 kg h⁻¹ of NaAlg upstream, accommodating downstream processing of 1943 kg h⁻¹ of Ca(Alg)₂, over a 330 day operating year. This capacity accounts for 0.15 Mt per year of algal bioplastics, which links well to the current and future bioplastic productivity.⁹ The Ca(Alg)₂ plant was assumed to be built in proximity to the Mayaro/Manzanilla coastline (10.2803° N, 61.0297° W) in East Trinidad, on the Atlantic side of the island where the largest influx of *Sargassum natans* occurs in the country. This significantly reduces the cost of harvesting, processing and transporting of the raw material feedstock. The wet seaweed feedstock required annually for the plant is 0.25 Mt – with abundant regional *Sargassum* supply chains available across the Caribbean Sea, Central West Atlantic, Central East Atlantic, and the Gulf of Mexico.

2.2.1 Seaweed pre-treatment. The raw seaweed feedstock was stored in well-ventilated sheds⁵¹ and dried using solar radiation. Next, seaweed washing was carried out on rotating conveyor belts outfitted with water hoses to remove soluble salts followed by formaldehyde treatment, using 2 (v/v) % in a ratio of 1 : 2 (seaweed : formaldehyde) for the removal of phenolic compounds.^{19,52} Wet treated seaweed was further dried to a moisture content of <10%, at 80 °C for 2 hours using a continuous rotary (19.82 MW) dryer.⁵³ Subsequently, the dried seaweed was pulverized to an average particle size of 505 μm (ref. 19) and stored in silos, in an inert atmosphere at ambient conditions.

2.2.2 Acid treatment. Dried seaweed was reacted isothermally with 0.5 M H₂SO₄ for 1 hour at 40 °C.¹⁹ Here, insoluble magnesium and calcium salts were converted to alginic acid (HALg) while acid-soluble phenolic compounds were removed as shown in eqn (1):

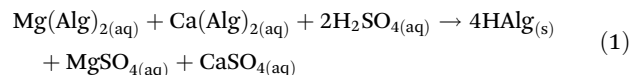

Subsequently, the products were centrifuged at 8000 rpm and the supernatant, comprising mainly of wastewater and biomass residue was stored in holding tanks prior to alkaline extraction.

2.2.3 Alkaline extraction. The residual seaweed biomass was reacted with 3.75 wt% Na₂CO₃ for 6 hours at constant temperature (80 °C),²⁰ whereby HALg was converted to NaAlg



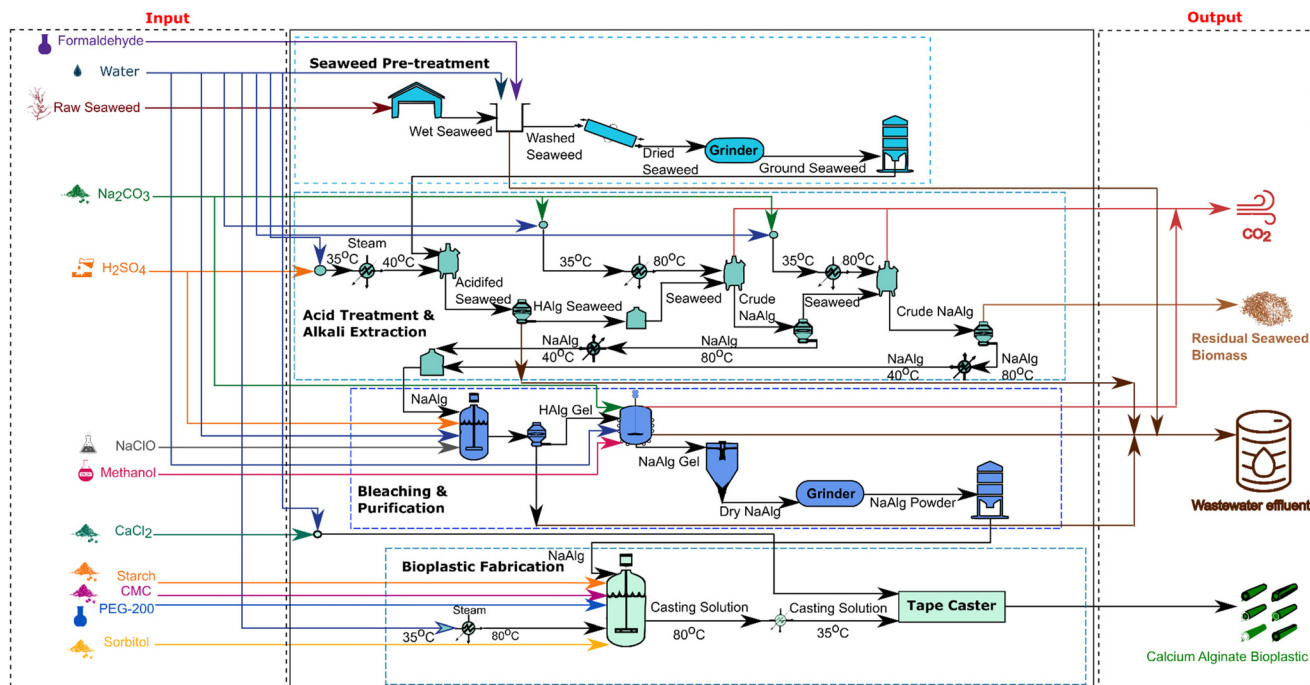

Fig. 1 Process flow diagram (PFD) of the $\text{Ca}(\text{Alg})_2$ bioplastic composite derived from *S. natans*. The main sections of the flowsheet are as follows: seaweed pre-treatment, acid treatment and alkali extraction, bleaching and purification and bioplastic fabrication. The structure of the PFD also includes inputs in the form of feedstocks, chemicals, reinforcement materials, plasticizers, utilities, and outputs – mainly CO_2 emissions, wastewater and biomass.^{20,21}

(eqn (2)). Reaction temperature was maintained using low pressure steam at 5 bars (duty = 2.4 MW).



After extraction, the mixture was centrifuged, and the residue was utilized in a second stage extraction step while the supernatant (crude NaAlg) was cooled to 40 °C (2.15 MW) and stored prior to precipitation. The second stage extraction step was repeated using similar process conditions as described previously. The total process CO_2 emissions for both extraction stages was approximately 1.08 mg kg^{-1} of crude NaAlg produced.

2.2.4 Bleaching and precipitation. Crude NaAlg was bleached at 28 °C for 30 minutes using a ratio of 1 : 80 (v/v) % ($\text{NaClO} : \text{NaAlg}$) followed by the addition of 0.5 M H_2SO_4 .²⁰ In this step, the crude NaAlg was precipitated as insoluble HALg thus, allowing for the easy removal of the wastewater residue. Any residual Na_2CO_3 was also neutralized in this step as shown in eqn (3) and (4).

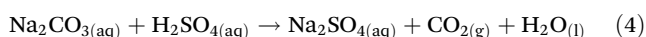

The HALg gel was subsequently mixed with 25 (v/v) % methanol (MeOH) solution and 5 wt% sodium carbonate (Na_2CO_3),²⁰ converting the HALg into pure NaAlg. The CO_2 released during this step was approximately 0.09 kg kg^{-1} of NaAlg precipitated.

2.2.5 Drying and milling. A spray dryer was used to dry the NaAlg gel (5.07 MW). A spray dryer was chosen as it is the preferred method of drying for thermally sensitive materials with a fine particle size and has been used frequently in drying alginate materials.^{54–56} The NaAlg was dried at 80 °C at a rate of 1000 kg h^{-1} .⁵⁷

2.2.6 Fabrication of $\text{Ca}(\text{Alg})_2$ bioplastics. Deionized water, preheated to 80 °C (875 kW), was thermo-mixed with NaAlg powder, starch, carboxymethyl cellulose (CMC), sorbitol and polyethylene glycol-200 (PEG-200) for 2 hours in a jacketed mixer (1.15 MW). Subsequent to thermo-mixing and homogenization, the casting solution was cooled to 35 °C (932 kW), loaded onto a tape caster – outfitted with a drying chamber and roller,^{58,59} and crosslinked with 6 wt% calcium chloride (CaCl_2). Finally, the $\text{Ca}(\text{Alg})_2$ bioplastics were dried at 60 °C for 5 hours (5.38 MW), rolled into 6 km long, 600 mm wide sheets and stored for distribution.

2.3 Environmental impact assessment

The environmental impact of the bioplastic process was measured using a consequential LCA following the EN ISO 14040 (2006) LCA⁶⁰ framework: (i) study goal and scope, (ii) life cycle inventory analysis, (iii) life cycle impact assessment and (iv) interpretation. The proposed cradle-to-gate system boundary, illustrated in Fig. 2, highlights the goal and scope for this study and considers the environmental impact of the $\text{Ca}(\text{Alg})_2$ bioplastic production phase compared to current business-as-usual (BAU) plastics and bio-based polymers – PET



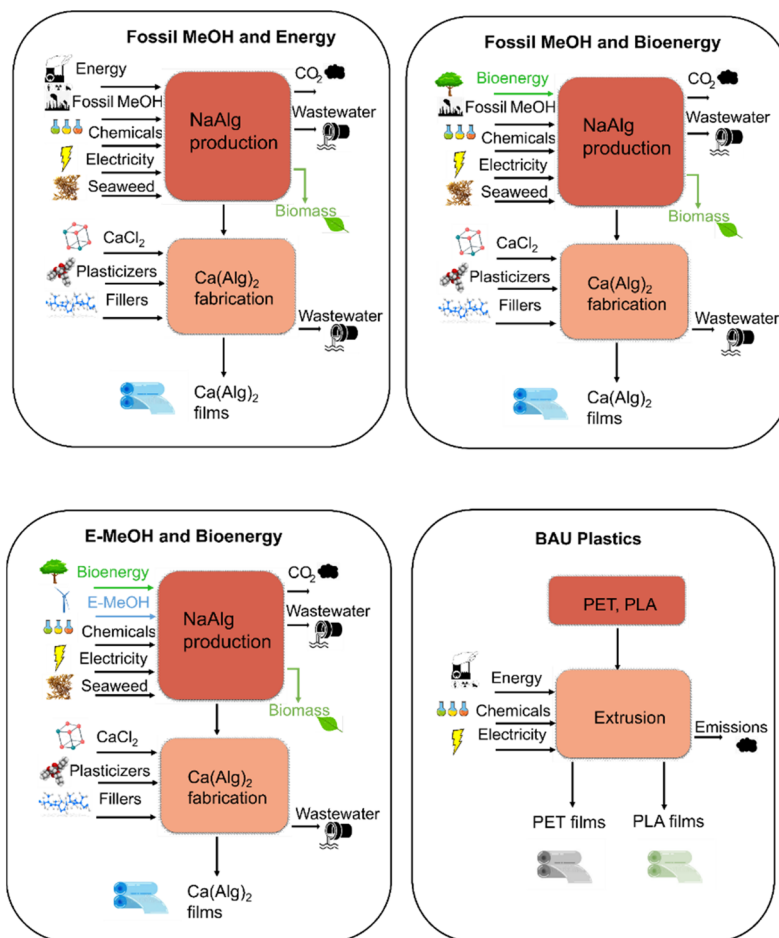

Fig. 2 Proposed system boundary definitions for different scenario-specific alginate bioplastic production phases compared to current BAU plastics (PET) and bio-based polymers (PLA).

and PLA.^{61,62} Oxygen barrier was chosen as the specific plastic property for quantifying the functional unit. Based on our previous work,²¹ the bioplastic composite material possesses ultra-low oxygen barrier properties—which makes it ideal as a food-packaging alternative.⁶³ Here, our bioplastic composite material was designed for ultra-low oxygen barrier as the key performance indicator aligned to food packaging. PET and PLA are quite common, high technology readiness level, commercial plastics and thus are strong candidates for comparison. Thus, comparison based on other functional properties such as tensile strength or water resistance would call for a new bioplastic design, which can be considered across a range of *Sargassum*-derived, fit for purpose, bioplastic products in the future. In meeting similar oxygen barrier performance for comparison purposes, eqn (5) and (6) were used to estimate the equivalent plastic mass of PET and PLA, given an arbitrary plastic film area, A , of 1 m^2 .

$$\frac{m_{\text{plastic}}}{m_{\text{bioplastic}}} = \frac{B_{\text{plastic}} \rho_{\text{plastic}}}{B_{\text{bioplastic}} \rho_{\text{bioplastic}}} \quad (5)$$

$$m_{\text{bioplastic}} = l_{\text{bioplastic}} \rho_{\text{bioplastic}} A \quad (6)$$

where m_{plastic} , B_{plastic} , ρ_{plastic} are the equivalent mass, oxygen barrier and density of PET and PLA respectively, and $m_{\text{bioplastic}}$, $B_{\text{bioplastic}}$, $\rho_{\text{bioplastic}}$, $l_{\text{bioplastic}}$ are the mass, oxygen barrier, density and thickness of the bioplastic composite material. The derivations of eqn (5) and (6) are given in ESI-Section 2.1.† In estimating the density of the bioplastic material, helium pycnometry (Accupyc II 1340, Micrometrics Ltd, Hexton, UK), equipped with a 1 cm^3 measuring chamber, was used. For effective dehydration prior to analysis, each of the five (5) representative bioplastic samples were dried overnight under vacuum at $50 \text{ }^\circ\text{C}$. The corresponding mass, thickness and properties of all materials are given in Table 1.

The inventory for the bioplastic process (cradle-to-gate) (Table 2) was derived from mass and energy balances across four distinct stages (Fig. 1) – seaweed preparation, acid pre-treatment, alginate extraction and bleaching, and finally composite design and bioplastic production.

Life cycle inventory flows consisted of raw materials and utilities – heating, cooling and electricity, while the main outputs were bioplastic, wastewater, CO_2 and waste biomass. In addition, environmental burdens aligned to the construction phase were omitted, as the main contributions to the overall



Table 1 Specific oxygen barrier, density, thickness and equivalent mass of the plastic materials tested

Plastic material	B (cm ³ μm per m ² per day per kPa) ²¹	ρ (kg m ⁻³)	l (μm)	Equivalent mass, m (kg)	$\frac{m_{\text{plastic}}}{m_{\text{bioplastic}}}$ (kg kg ⁻¹)
PET	236.67	1400 ⁶⁴	54	131.98	978.24
PLA	17.75	1210 ⁶⁵	56	8.60	63.68
Ca(Alg) ₂ bioplastic	0.2	1686	80	0.135	1

Table 2 Normalized input–output data and energy profiles per kg of Ca(Alg)₂ produced

Raw materials	
Raw wet seaweed/kg	16.54
Formaldehyde/kg	0.66
H ₂ SO ₄ /kg	2.67
Na ₂ CO ₃ /kg	1.33
NaOCl/kg	0.70
MeOH/kg	1.69
CaCl ₂ /kg	0.51
Process water/kg	287.36
Starch/kg	0.02
CMC/kg	0.03
Sorbitol/kg	0.03
PEG-200/kg	0.01
Utilities	
Electricity/kW h	0.287
Heating/MJ	78.35
Cooling/MJ	9.69
Emissions	
Water lost to drying/kg	26.85
Wastewater/kg	281.49
<i>Sargassum</i> biomass/kg	1.84
CO ₂ /kg	0.39
Products	
Ca(Alg) ₂ bioplastic/kg	1

environmental impact were linked to the use of raw materials and utilities, and emissions associated with the plastic production processes.^{66,67} Biogenic CO₂ credits were assigned to the *Sargassum* biomass accordingly⁶⁸ while burdens allocated to the waste biomass by-product were avoided (system boundary expansion), through its utilization within the local agricultural sector.⁶⁹ Upstream inventories associated with raw material extraction, transport and extrusion (processing), were all derived from Ecoinvent v3.4 databases (ESI-Section 2.3†). It is worth noting that transportation of the *Sargassum* biomass was assumed to be minimal given the close proximity of the bioplastic production facility to the harvesting points along the Western Coast of Trinidad and Tobago.

The environmental impact was characterized by the ReCiPe 2016 H (hierarchist) model at the midpoint stage, defined and calculated using SimaPro V8. The midpoint characterization model utilizes 18 impact categories: global warming (GHG), ozone depletion, ionizing radiation, ozone formation (human health), particulate matter formation, ozone formation (terrestrial ecosystems), acidification, freshwater eutrophication, marine eutrophication, terrestrial ecotoxicity, freshwater ecotoxicity, marine ecotoxicity, human carcinogenic toxicity, human non-carcinogenic toxicity, land utilization, resource scarcity, fossil scarcity and water consumption – for which the overall performance of each plastic product was assessed and

compared (ESI-Section 2.3†). Furthermore, scenario specific environmental impacts were considered, whereby potential environmental benefits of cleaner supply chains, incorporating E-MeOH and bioenergy in line with Trinidad and Tobago's ambitions on green MeOH,⁷⁰ are compared to BAU processes. For this study, relevance on the environmental impact interpretation was placed on GHG emissions. However, to illustrate and inform on possible burden shifting, consideration was also placed on those impact categories where environmental benefits (trade-offs) were not observed across scenarios.

Trinidad and Tobago, where our conceptual plant is located, is one of the world's largest MeOH producers, relying on its large natural gas fields.⁷¹ However, recent ambitions in carbon capture and storage *via* enhanced oil recovery,⁷² as well as a significant wind power resource⁷³ has linked the growing energy sector to cleaner supply chains. Thus, all of these features make Trinidad and Tobago an ideal future hub for E-MeOH and would offer a sustainable feedstock in the alginate bioplastic production process. Although still a very small part of Trinidad and Tobago's energy supply, renewables are steadily increasing, and in 2019, bioenergy represented 93% of all its renewable energy.⁷⁴ Bioenergy is therefore also a logical alternative choice of heat and power in the alginate plastic manufacturing process, relying on the local healthy agribusiness and forestry industry.

2.4 Economic assessment

The economic viability of the manufacturing process was analyzed using total annualized cost (TAC) as the performance indicator. The economic feasibility of the process was evaluated by calculating the TAC at an interest rate of 15% over an estimated investment lifetime of 10 years.⁷⁵ Due to the lack of detailed engineering quotations, a class III costing approach⁷⁶ was used to estimate the capital expenditure (CAPEX). Therefore, different costing methodologies clearly defined and presented in past TEA studies,^{75,77,78} such as bare module cost,⁷⁶ lang factor and power factor⁷⁹ methodologies were used in developing CAPEX costs.

Region specific parameters aligned to Trinidad and Tobago as well as market analysis and costing data were utilized in determining operating costs (OPEX) associated with raw materials, utilities and labour – presented in Table 3. In the absence of information on the current market, consumer prices were used and inflated to 2019 prices. A detailed overview of the calculations used in estimating CAPEX and OPEX costs are given in ESI-Section 1.1.† Finally, a sensitivity analysis was carried out on the most significant contributing



Table 3 Region specific economic parameters used in determining TAC for the alginate bioplastic composite process flowsheet

Parameter	Value
Depreciation method ⁷⁶	Straight line
Cost year for analysis	2019
CEPCI 2019 ⁸⁰	619.2
Operating hours (h y ⁻¹) ⁷⁹	7920
H ₂ SO ₄ (\$US per MT) ⁷⁶	94
Na ₂ CO ₃ (\$US per MT) ⁸¹	233
MeOH (\$US per MT) ⁸²	430
Formaldehyde (\$US per MT) ⁸³	201
NaOCl (\$US per MT) ⁸⁴	69
Starch (\$US per MT) ⁸⁵	610
CMC (\$US per MT) ⁸⁶	2410
Sorbitol (\$US per MT) ⁸⁷	638
PEG-200 (\$US per MT) ⁸⁸	2000
CaCl ₂ (\$US per MT) ⁸⁹	351
Low pressure steam (\$US per GJ) ⁷⁶	2.78
Cooling water (\$US per GJ) ⁷⁶	0.378
Process water (\$US per MT) ⁷⁶	1.52
Electricity from grid (\$US per kW h) ⁹⁰	0.0264

factors to the TAC of the Ca(Alg)₂ bioplastic to determine the outlook on the future market growth.

3. Results and discussion

An overview of the results of the techno-economic and environmental assessments of our Ca(Alg)₂ bioplastic process is described here. Case-specific inventories linked to the pre-defined system boundaries were derived from mass and energy balances and utilized to measure both environmental and economic sustainability, in comparison to BAU synthetic and bio-based plastics. Firstly, the environmental performance details the major contributions to GHG impact, highlighting and providing solutions to hotspot areas of concern while evaluating Ca(Alg)₂ bioplastic performance in meeting ultra-low oxygen barrier. Secondly, the economic performance considers the impact of various feedstock and utility costs on both Na(Alg) and Ca(Alg)₂ production as well as considers the overall sensitivity of market prices on the future economic sustainability of our Ca(Alg)₂ bioplastic. Finally, from assessing both performance indicators, local policies were constructed to promote a vibrant and sustainable alginate bioplastic industry within the Caribbean region.

3.1 Environmental performance

The environmental impact of the bioplastic process and the effect of supply chain environmental burdens are presented in Fig. 3. For BAU bioplastic production, main hotspots identified were associated with energy consumption across the bioplastic flowsheet-heating (61%), as well as chemical consumption attached to NaAlg extraction and production – Na₂CO₃ (16%), MeOH (11%), NaOCl (18%) and H₂SO₄ (5%), and *Sargassum* pre-treatment – formaldehyde (6.4%). It is worth noting that the wastewater generated in the manufacture of the alginate bioplastic would have a significant content in sulfates from

the acid treatment and bleaching steps. However, special treatment of such wastewater can be addressed by ultrafiltration at local wastewater plants, and this can be met by the local manufacturing industry and wastewater treatment facilities.^{91,92}

Minor GHG impacts, cumulatively up to 12%, were linked to other processes such as plasticizer (PEG-200, sorbitol) and reinforcement material use (starch, CMC), water, electricity consumption and wastewater treatment. Environmental burdens from these processes correspond to the release of CO₂, CH₄ and N₂O arising from raw material extraction, processing, and fossil fuel consumption. Apart from GHG burdens, significant environmental benefits were aligned to seaweed biogenic CO₂ uptake; avoiding up to 33% GHG emissions while the utilization of residual biomass in agriculture contributes up to 2% of the GHG offset.

Considering the normalized GHG impact (kg CO₂eq per kg plastic) across plastic products shows major burdens aligned to polymer manufacturing across all materials. For PET plastics, 85% of the normalized impact lies in polymerization (ESI-Section 2.3†), while 15% of the emissions arise from extrusion and fabrication. Upon comparison, PLA production yields similar results; however, biogenic CO₂ uptake from the use of corn results in 61% avoided GHG emissions. Overall, our results illustrate BAU bioplastic production to be largely GHG emitting, producing 3–7 times as much CO₂ emissions as PET and PLA (Fig. 3). Similar findings have been reported on composite materials,⁶⁵ emphasizing the influence of embedded supply chain environmental burdens on GHG impact. On substituting bioenergy for heating within the bioplastic flowsheet accounts for a 74% reduction in the normalized GHG impact, decreasing emissions to 4.67 kg CO₂eq per kg bioplastic. Ultimately, by further incorporating E-MeOH supply chains, normalized GHG impact reduces by 79% across the bioplastic system and 43% compared to PET processing. Thus, with the advent of new efficient technologies, utilization of cleaner energy sources and raw materials, and the intervention of circular process integration strategies,⁷⁵ net GHG impact is expected to further decrease-supporting low carbon processes.⁹³

While normalized quotas for the bioplastic process shows high GHG impacts, the total GHG emissions (kg CO₂eq) produced for an equivalent mass of plastic material in meeting ultra-low oxygen barrier properties (Table 1) were 978 and 64 times lower than that of PET and PLA. Focusing on the equivalent mass of each material, PET performs the worse at a total GHG impact of 498 kg CO₂eq while PLA produces 11.85 kg CO₂eq. Thus, for an effective plastic packaging with high oxygen resistance, our alginate bioplastic composite outperforms with total GHG impact varying between 0.3–1.37 kg CO₂eq aligned to BAU and low carbon operations.

In promoting sustainable operations of the bioplastic production flowsheet, significant burden shifting was observed across human non-carcinogenic toxicity, land use, and terrestrial ecotoxicity (Fig. 3) – whereby collateral damage arises from the intervention of both bioenergy and E-MeOH within the process design. Focusing on BAU bioplastic production, the highest environmental burdens across land use, human



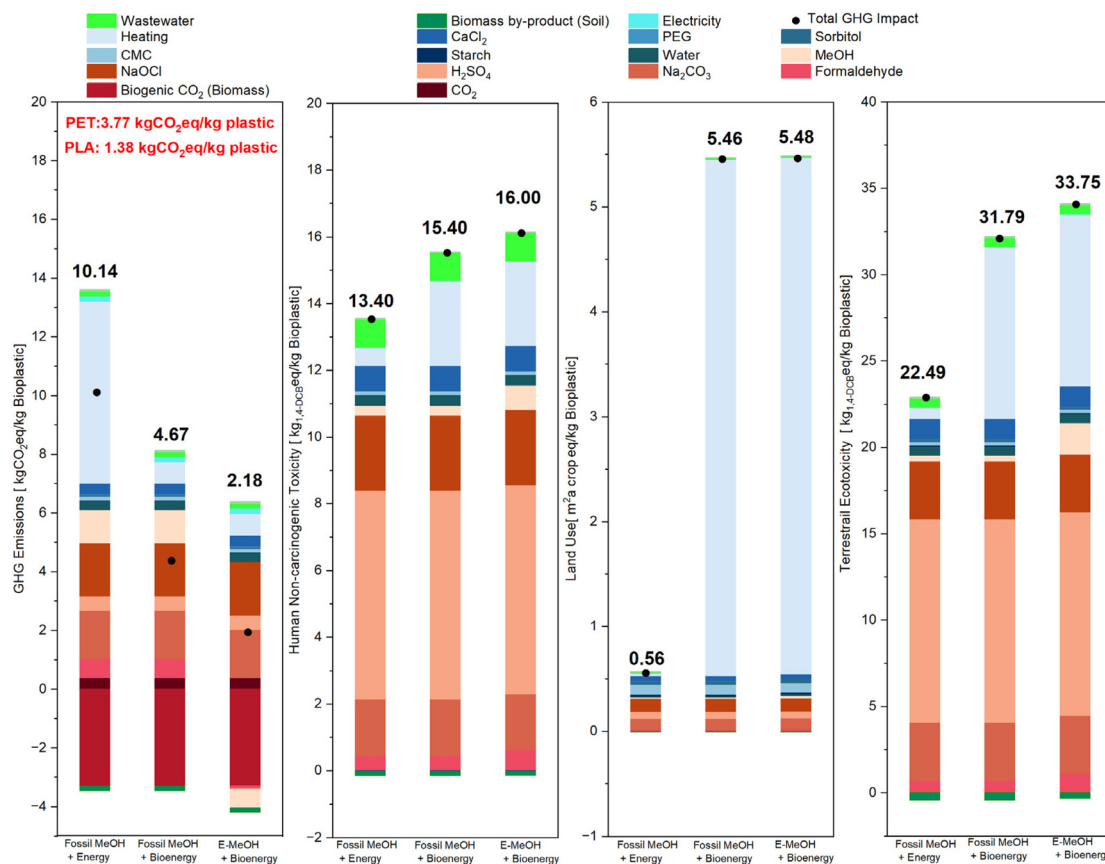

Fig. 3 Case specific characterized cradle-to-grave LCIA results using ReCiPe 2006 (H) methodology: GHG (GWP_{100a}), human non-carcinogenic toxicity, land use and terrestrial ecotoxicity for BAU bioplastic production using fossil-based MeOH and energy compared to cleaner processes incorporating E-MeOH and bioenergy. Normalized GHG emissions presented for synthetic (PET) and bio-based (PLA) plastics.

non-carcinogenic toxicity and terrestrial ecotoxicity were associated with Na₂CO₃ (13–18%), H₂SO₄ (12–52%) and NaClO (15–22%) production. These impacts were linked to the release of Zn, As, Cr and V related to mining, quarrying and fossil fuel extraction activities as well as land transformation and occupation. Through the inclusion of low carbon heating and E-MeOH, the overall impact across these categories worsen – with a 19–50% increase reported for human non-carcinogenic toxicity and terrestrial ecotoxicity, and up to 9 times higher impacts estimated for land use. The highest burdens (30–90%) were associated with the use of wood chips for bioenergy, leading to shifts in forest transformation and the release of metals embedded within waste streams. Although burden-shifting is considered problematic in proposing new processes aiming at promoting sustainable operations, our results (ESI-Section 2.3†) illustrate incurred environmental benefits across 15 of the 18 impact categories – supporting the need to offset GHG impact through low carbon supply chains.

3.2 Economic performance

To better understand the economic feasibility of plastic fabrication and production process scheme, TAC was analyzed at both the biopolymer production (Fig. 4) and bioplastic manu-

facture (Fig. 5) phases of the proposed flowsheet (Fig. 1). Focusing firstly on NaAlg production, Fig. 4 highlights the TAC per kg NaAlg and the influence of the raw materials, utilities, labor costs, capital costs and fixed costs on the overall raw material price. The TAC was found to be \$US 5.94 per kg NaAlg, with MeOH, Na₂CO₃, capital costs and fixed costs contributing the most to the TAC – up to 26%, 10%, 5% and 31% respectively. These high contributions among inputs were attributed to the material flows within the process structure coupled with high market prices. Mass balancing (Table 2) shows significant amounts of Na₂CO₃ (2584 kg h⁻¹) and MeOH (3287 kg h⁻¹) were used in the multistage extraction and precipitation sub-processes. Additionally, high costs aligned to operating labour, capital investment and contingencies were owed to the large number of equipment present within the processing steps. Considering the bioplastic production phase, the Ca(Alg)₂ TAC (Fig. 5) was found to be \$US 4.56 per kg – with NaAlg and fixed costs contributing the most at 67% and 21% respectively. Given the overall process, the TAC for the bioplastic is directly proportional to its raw material and thus, the cost in processing and extracting NaAlg carries the largest contributions in promoting a feasible bioplastic manufacturing route.



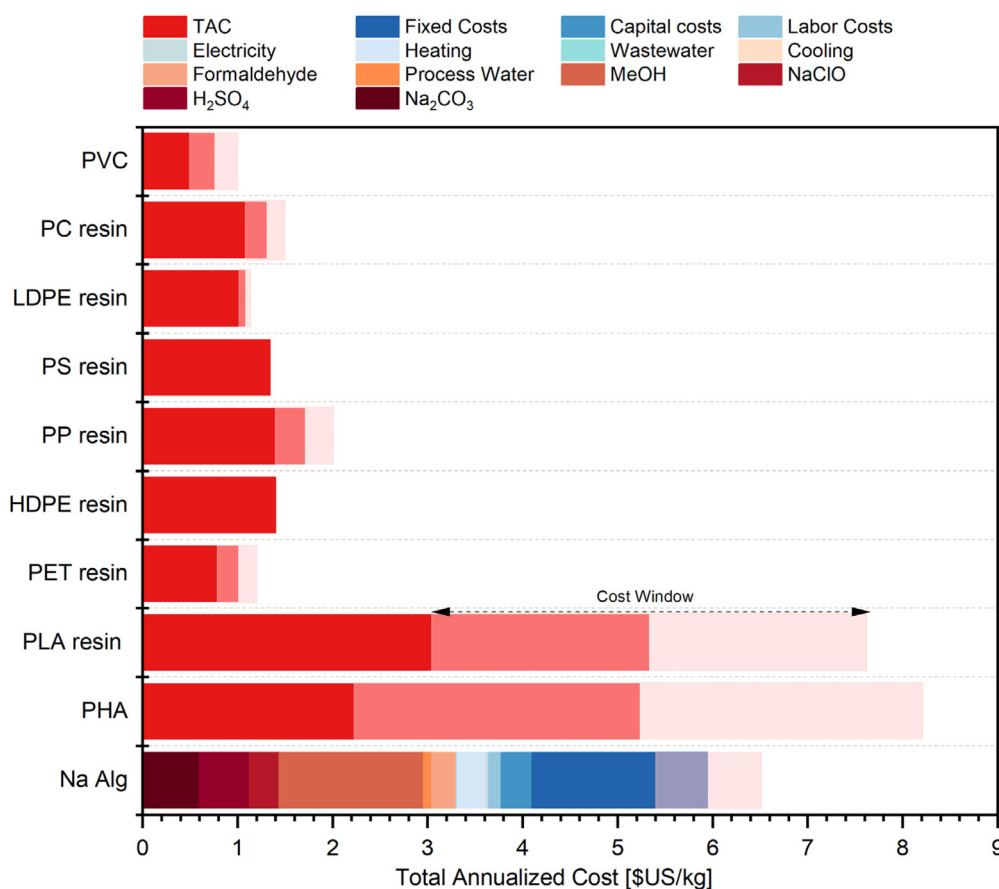

Fig. 4 TAC breakdown for NaAlg as a function of raw materials (formaldehyde, H_2SO_4 , Na_2CO_3 , MeOH, NaClO, process water), fixed costs, capital costs, labor costs, utilities (electricity, heating, cooling), with a direct comparison to synthetic plastic and bio-based resins. Synthetic plastics include: PVC (polyvinyl chloride), PC (polycarbonate), LDPE (low density polyethylene), PS (polystyrene), PP (polypropylene), HDPE (high density polyethylene) and PET (polyethylene terephthalate). Bio-based resins include: PLA (polylactic acid) and PHA (polyhydroxyalkanoates). Cost window signifies variability within current market prices.

The decrease in TAC observed from raw material to final plastic product is an uncharacteristic attribute of the $\text{Ca}(\text{Alg})_2$ bioplastic process. From comparing synthetic and bio-based sources given in Fig. 4 and 5, TAC generally gets more expensive. However, for the $\text{Ca}(\text{Alg})_2$ bioplastic, the TAC was found to decrease by 23% moving from raw material to final product. This was linked to the production capacity and the inherent energy and resource intensity of the NaAlg production. The process was designed to produce 7.92 kilotons per annum (kt per a) of NaAlg, which subsequently produces 15.4 kt per a of $\text{Ca}(\text{Alg})_2$ bioplastic. The larger production of $\text{Ca}(\text{Alg})_2$ results in cost advantages due to economies of scale.⁹⁴ This production capacity is not uncommon for bioplastics as it fits within the range (1–140 kt per a) for current PLA processes.⁹⁴

In comparing the TAC of both NaAlg material and $\text{Ca}(\text{Alg})_2$ bioplastic, the cost variability was significantly lower than conventional PHA and PLA as well as PC products. Comparing NaAlg raw material cost to the synthetic and bio-based alternatives (Fig. 4), NaAlg cost window (\$US 5.35 per kg–\$US 6.54 per kg) was more stable than those of virgin bio-based resins—PLA and PHA (\$US 2.33 per kg–\$US 8.22 per kg) – with NaAlg cost

falling within the range for bio-based resins. However, the NaAlg cost was approximately 3–7 times higher than the cost of synthetic plastic resins such as PET, HDPE, PP, PS, LDPE, PC and PVC (\$US 0.75 per kg–\$US 1.7 per kg). The current consumer price of NaAlg is in the range of \$US 1.6 per kg–\$US 6.9 per kg (ref. 95) and it can be seen that our NaAlg production scheme is on the higher end of the range. This can be attributed to the fact that commercially available NaAlg supply chains are derived from high alginate yield seaweeds (35% higher than *Sargassum* *Laminaria digitata* and *Macrocystis pyrifera*, which are farmed and harvested).⁹⁶ Fig. 5 shows the cost of the $\text{Ca}(\text{Alg})_2$ bioplastic to be significantly lower (62–71%) than the cost of PLA sheets and approximately 159–310% higher than the cost of the fossil-based plastic sheets (\$US 1.4 per kg–\$US 3.0 per kg), with the exception of PC plastic sheets. In addition, the cost window for the PLA sheets (\$US 6.15 per kg–\$US 7.65 per kg) indicates a high variability to changes in market prices as compared to the $\text{Ca}(\text{Alg})_2$ bioplastic (\$US 4.35 per kg–\$US 4.77 per kg).

This observed non-competitiveness of bioplastics compared to fossil-based synthetic polymers is not surprising as previous



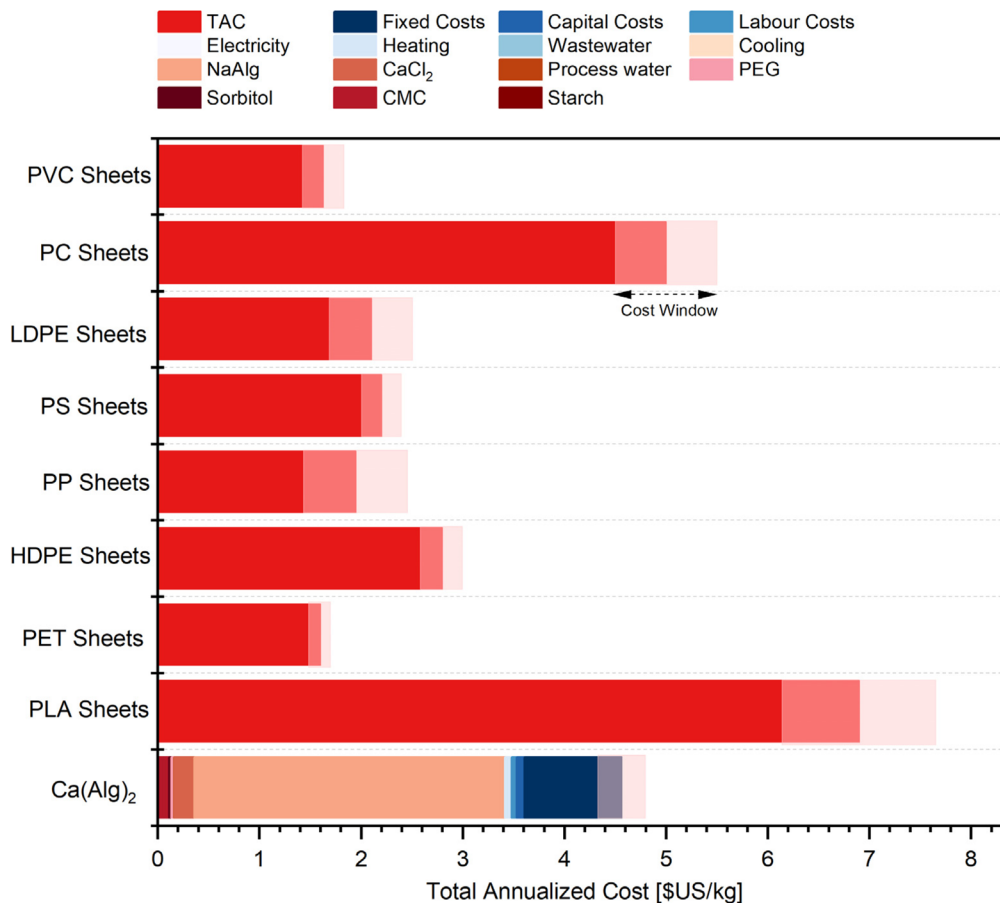

Fig. 5 TAC breakdown for $\text{Ca}(\text{Alg})_2$ bioplastic as a function of raw materials (NaAlg, sorbitol, CaCl_2 , CMC, process water, starch, PEG-200), fixed costs, capital costs, labor costs, utilities (electricity, heating, cooling), with a direct comparison to synthetic plastic and bio-based sheets. Synthetic plastics include: PVC (polyvinyl chloride), PC (polycarbonate), LDPE (low density polyethylene), PS (polystyrene), PP (polypropylene), HDPE (high density polyethylene) and PET (polyethylene terephthalate). Bio-based sheet include: PLA (polylactic acid). Cost window signifies variability within current market prices.

work has shown significant price variations between the two plastic types⁹⁷ – mainly linked to lower commodity prices and higher process scalability favoring fossil-based routes.⁹⁸ Nonetheless, $\text{Ca}(\text{Alg})_2$ bioplastic sheets are on the higher end of the range for conventional bioplastics attributed to higher raw material costs embedded within the use of low-quality seaweeds. Ultimately, our results showcase the cost competitiveness of $\text{Ca}(\text{Alg})_2$ bioplastics within current bio-based markets, and the overall infeasibility among synthetic production schemes.

In promoting a low carbon $\text{Ca}(\text{Alg})_2$ process, Fig. 6 illustrates the cost variability in embedding sustainable supply chains, through bioenergy and E-MeOH, within the BAU bioplastic flowsheet. Our results highlight the feasibility of bioenergy integration, with a 5% increase in TAC, compared to expensive E-MeOH production-which results in a 23% increase in the overall $\text{Ca}(\text{Alg})_2$ cost. As global E-MeOH supply chains emerge and CO_2 -based MeOH competes with fossil-based technologies,⁹⁹ the expectation is that future low carbon $\text{Ca}(\text{Alg})_2$ economic feasibility will greatly improve.

In terms of cost contributions, the intrinsic nature of the $\text{Ca}(\text{Alg})_2$ flowsheet; even with the consolidation of low carbon supply chains, gives similar results-with NaAlg dominating (65–72%) the overall economic sustainability of the bioplastic process. While comparing the low carbon $\text{Ca}(\text{Alg})_2$ TAC (Fig. 6) to other plastics shows a cheaper alternative to PLA but much more expensive replacement to PET, the total cost reveals competitive advantages – with PET packaging costing 280 times more than low carbon $\text{Ca}(\text{Alg})_2$ in meeting ultra-low oxygen barrier. Thus, among the various packaging materials, low carbon $\text{Ca}(\text{Alg})_2$ emerges as a sustainable solution for oxygen-sensitive products.

3.3 Sensitivity analysis

A sensitivity analysis was conducted on the $\text{Ca}(\text{Alg})_2$ bioplastic process to investigate the effects of cost factors on TAC, as shown in Fig. 7. Sensitivities were investigated using current and future market trends available for the largest contributors, notably: NaAlg, CaCl_2 and CMC, while fixed costs were varied by $\pm 20\%$ based on technology learning rates⁷⁹ and capital



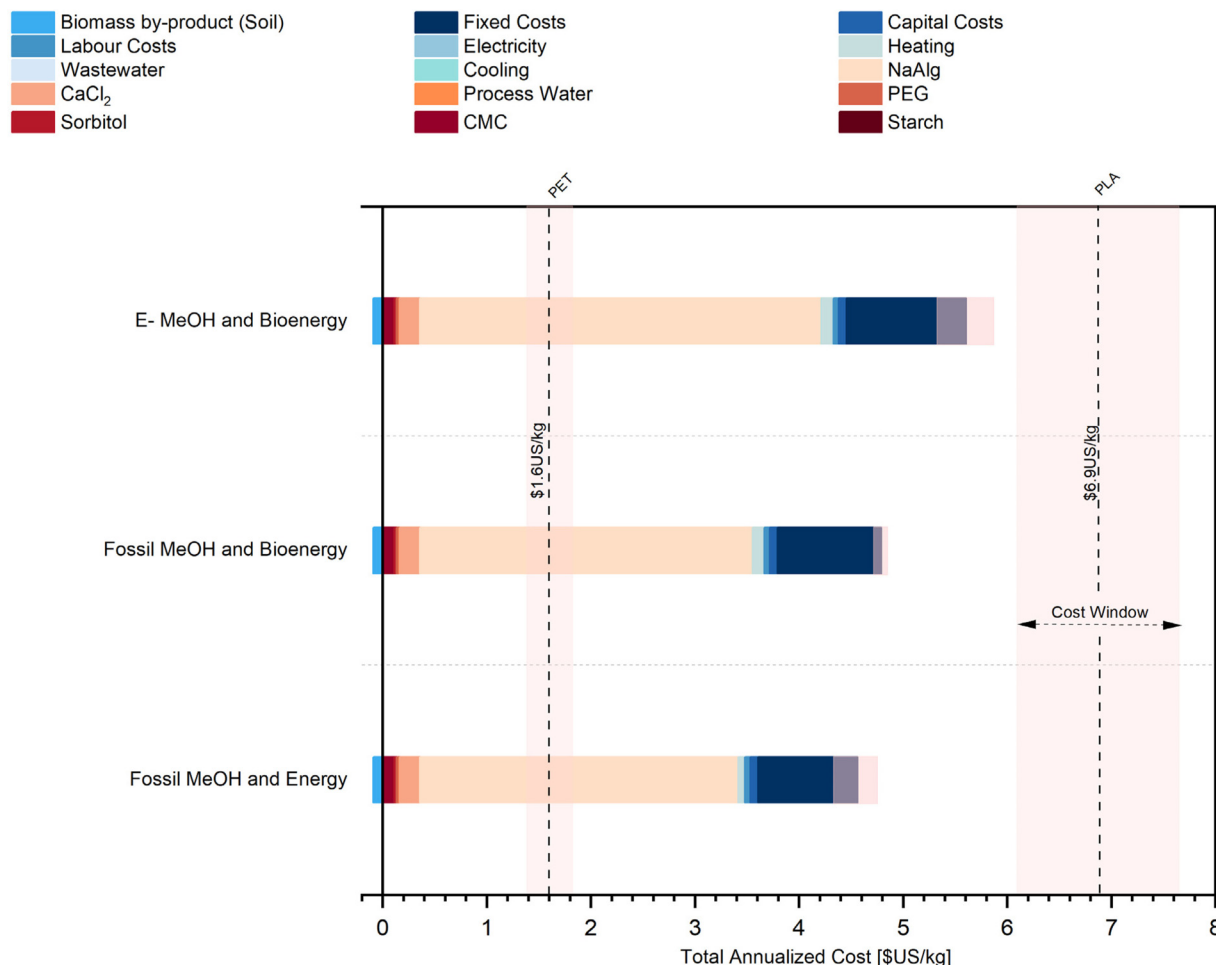

Fig. 6 Implemented LCA costs and the effect on TAC and breakdown as a function of raw materials (NaAlg, sorbitol, CaCl₂, CMC, process water, starch, PEG-200), fixed costs, capital costs, labor costs, utilities (electricity, heating, cooling), with a direct comparison to synthetic plastic PET and bio-based plastic PLA. The cost window shows cost variability within current market prices.

costs were varied by $\pm 25\%$ adapted from León *et al.* (2020).¹⁰⁰ From the analysis, capital cost, CaCl₂ and CMC exhibited little TAC sensitivity – between -0.4% to 0.4% , -0.4% to 1.3% and 0.4% to 1.1% respectively. Moreover, fixed costs produced marginal sensitivities to TAC at $\pm 4.2\%$, attributed to changes in depreciation, local taxes, insurance and contingencies.⁷⁶ Among all contributors, NaAlg was found to be the most sensitive with changes in TAC of -60% to $+13\%$. The current market price of NaAlg is very sensitive and is trending towards the lower end of the TAC range. Thus, the current price of our NaAlg raw material can be improved through process integration and optimization, lower equipment and chemical costs, enhanced technical development and better supply chain logistics.^{29,97,101} Furthermore, given that the Ca(Alg)₂ bioplastic industry is at a low technology maturity level, driving costs down are timely. According to the nine-point TRL scale,¹⁰² the alginate bioplastic industry currently stands at 5–6. At this level, mainly pilot scale systems are considered and therefore, exists potential for major growth through technological maturity coupled with

multiple production routes, valorization of waste material, forward-looking management of critical raw materials and exploitation of biotechnology.^{103–105}

3.4 Policy agenda

In order to further reduce the cost of the alginate bioplastic, scientific policy-oriented stimuli are required. A driver for the development of this policy framework is the establishment of the United Nations' 17 sustainable development goals (SDG's). In accordance to these goals, plastic production needs to involve the use of renewable sources without impacts on human health (SDG3), climate change (SDG13), life below water (SDG14), life on land (SDG15) and should involve resource circularity aiding in sustainable cities and communities (SDG11) and responsible production and consumption (SDG12).¹⁰⁶

In Trinidad and Tobago, the National Waste Recycling Policy⁴⁵ reports synthetic plastics account for 16–26% of the waste in four major landfills (Beetham, Forres Park, Guanapo and Guapo). This policy encourages the recovery of waste,



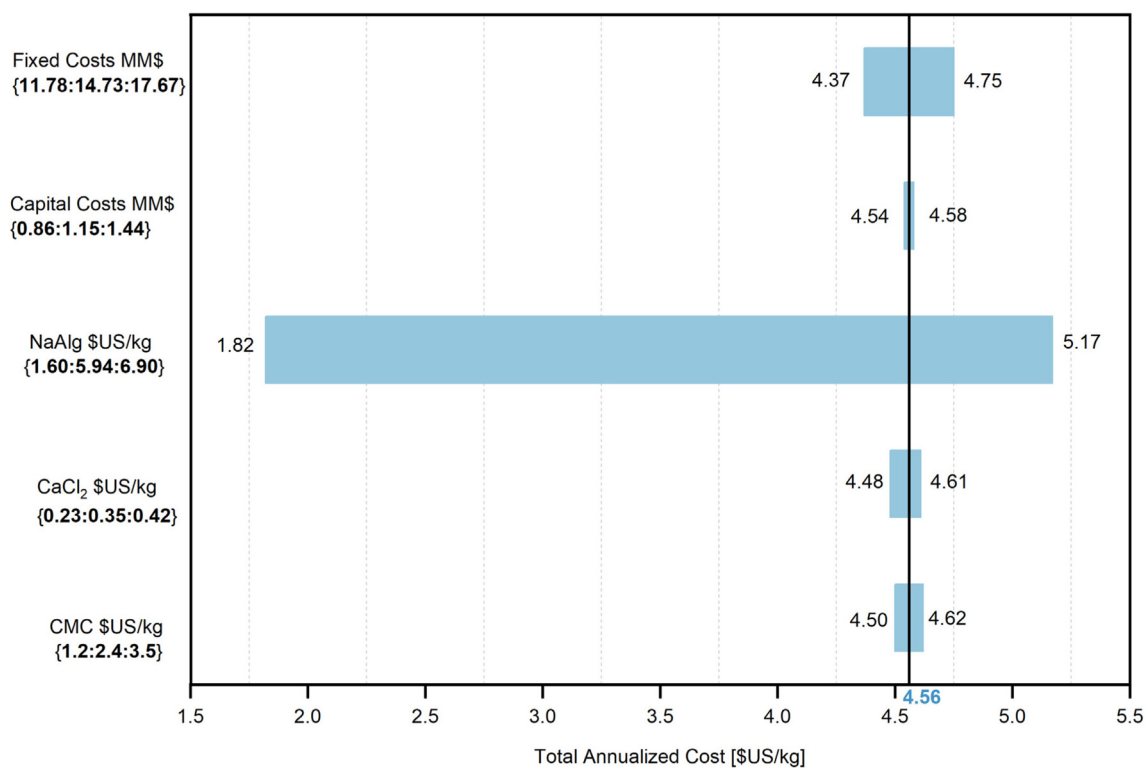

Fig. 7 TAC sensitivity of $\text{Ca}(\text{Alg})_2$ bioplastic as a function of cost variables. Major cost variables included fixed costs, capital costs and raw material (NaAlg, CaCl_2 and CMC) costs. For each cost variable, the base cost, illustrated as the center value in brackets, were varied showing the associated sensitivity on the TAC. Current $\text{Ca}(\text{Alg})_2$ TAC = \$US 4.56 per kg.

including recycling, reuse or reclamation, and the use of waste as a source of energy. In addition, the policy suggests that the removal of recyclable material from the waste stream, the reuse/recycling of such recyclable materials, and the promotion of composting by households, can extend the life and capacity of the existing landfills to meet the final waste disposal needs of the country. However, this is not implemented on a larger scale as records from the Trinidad and Tobago Solid Waste Management Company Limited indicate that a significant amount of recyclable materials (including plastics) are being disposed of at landfills instead of being recycled or valorized.⁴⁵ Consequently, this contributes to the on-going plastic pollution problem and leads to significant waste disposal issues. Therefore, there is strong motivation to innovate new sustainable materials that can replace synthetic plastics – with $\text{Ca}(\text{Alg})_2$ bioplastic as an excellent candidate.

However, there is very little to no information that exists in Trinidad and Tobago incentivizing the use and implementation of bioplastic materials. Firstly, government subsidies and grants can motivate companies to develop partnerships between stakeholders in the supply chain, providing direct support and reducing the expenses involved with the manufacturing of bioplastics.¹⁰⁷ Secondly, the implementation of fossil-based carbon taxes or tariffs on synthetic plastics can further increase economic feasibility.¹⁰¹ Moreover, landfill and plastic taxes for excessive plastic waste can be applied,

encouraging the use of sustainable plastic alternatives while promoting greater recycling and reuse among single use plastic packaging.¹⁰⁸

As the awareness of natural resources and environmental conservation increases, consumers are more likely to purchase bio-based materials thus, driving the demand for bioplastics.¹⁰⁹ This was observed in a study that evaluated the attitudes on Europeans to both plastics and bioplastics where 98% of participants were more engaged in reducing the use of plastics and adopting sustainable alternatives.¹¹⁰ Thus, similar environmental awareness campaigns can be adopted locally to stimulate such responses in citizens.

The results of this study illustrates the transferable value in utilizing *Sargassum* seaweed for the production of ultra-low oxygen barrier bioplastics across various levels. Economically, it serves as avenues to value creation and GDP growth across the Caribbean and the global bioplastics industry – directly competing with commercial alternatives. Additionally, it informs on policies that can be adapted widely across the global plastic packaging network including, but not limited to the Ellen MacArthur Foundation, and United Nations Environment Program (UNEP) who are huge advocates and pioneers for changes in plastic packaging that are biodegradable, sustainable, and less polluting. In terms of translational value, our modelling framework provides technical knowledge aligned to clean energy integration, scale-up and



productivity, techno-economics and life cycle assessment methodologies, which can be transferred and incorporated into the development of novel industries, in alignment with UNSDGs.

Ultimately, the approach of sound policies aligned to plastic waste reduction coupled with improved consumer awareness can help to drive greater economic feasibility of a novel alginate bioplastic industry.

4. Conclusions

In mitigating the effects of *Sargassum* migration onto Caribbean shores while also advocating for sustainable packaging, this study presents a novel, calcium alginate composite bioplastic manufacturing process within Trinidad and Tobago. Economic feasibility and environmental impacts of the process flowsheet were evaluated using TEA and LCA methodologies, and results were compared to current BAU bio-based (PLA) and synthetic plastics (PET). Cradle-to-gate LCA results revealed 3–7 times greater GHG impacts linked to Ca(Alg)₂ bioplastic over PLA and PET films. For BAU bioplastic production, main hotspots identified were associated with energy (61%) and chemical consumption (50%) across the bioplastic flowsheet. In addition, the highest environmental burdens for BAU bioplastic production were observed for land use, human non-carcinogenic toxicity and terrestrial ecotoxicity – with Na₂CO₃ (13–18%), H₂SO₄ (12–52%) and NaClO (15–22%) as the main contributors. Through the integration of low carbon bioenergy and E-MeOH supply chains, GHG impact reduces by 79% – illustrating a pathway to a more sustainable bioplastic production flowsheet.

Additionally, economic assessments for NaAlg production gave a TAC score of \$US 5.94 per kg – with MeOH (26%), Na₂CO₃ (10%) capital costs (5%) and fixed costs (31%) contributing the most to the product price. Furthermore, the TAC for Ca(Alg)₂ bioplastic was \$US 4.56 per kg, ensuring a cost competitive alternative to current bio-based films but an overall expensive replacement to synthetic packaging. Moreover, insights into TAC sensitivity highlights variability mainly associated with sodium alginate prices – contributing up to 67% to the overall cost. However, in meeting ultra-low oxygen barrier properties, the Ca(Alg)₂ bioplastic outperforms – with a carbon footprint 64–978 times lower than PLA and PET respectively, and overall packaging costs 280 times lower than current synthetic plastic. Embedded within our environmental results, specific sensitivities were apparent, based on the functional unit. Thus, in order to foster higher economic viability of the alginate bioplastic industry and promote sustainable packaging options in line with the National Waste Recycling Policy of Trinidad and Tobago, effective policies need to be implemented. These include fossil-based carbon taxes or tariffs on synthetic plastics, landfill and plastic taxes for excessive plastic waste and improved consumer awareness as a means of incentivizing bioplastic alternatives while promoting greater recycling and

reuse among single use plastic packaging. Embedded within our environmental results, sensitivities were noted, linked to the functional unit of the plastic material. While our bioplastic product was fit for purpose, aligned to ultra-low oxygen barrier, comparison to other material properties such as tensile strength and water resistance would call for a radical new design. Thus, broader product development can be considered in future work, whereby *Sargassum*-derived bioplastic materials can play a role in meeting specific properties across packaging needs. Ultimately, our study illustrates a feasible and sustainable alginate bioplastic substitute, encouraging and informing packaging innovation while attaining low carbon operations within the Caribbean plastic sector aligned with the UNSDGs.

Abbreviations

BAU	Business as usual
CaCl ₂	Calcium chloride
CAPEX	Capital costs
CEPCI	Chemical engineering plant cost index
CMC	Carboxymethyl cellulose
E-MeOH	E-methanol
GHG	Greenhouse gases
GJ	Gigajoule
GWP ₁₀₀	Global warming potential
H ₂ SO ₄	Sulphuric acid
HDPE	High density polyethylene
LCA	Life cycle assessment
LCIA	Life cycle impact assessment
LDPE	Low density polyethylene
M	mol dm ⁻³
MeOH	Methanol
MJ	Megajoule
Mt	Million tons
MT	Metric ton
MW	Megawatt
Na ₂ CO ₃	Sodium carbonate
NaOCl	Sodium hypochlorite
OPEX	Operating expenditure
PC	Polycarbonate
PEG	Polyethylene glycol
PET	Polyethylene terephthalate
PFD	Process flow diagram
PHA	Polyhydroxyalkanoates
PHB	Polyhydroxybutyrate
PLA	Poly(lactic acid)
PP	Polypropylene
PS	Polystyrene
PVC	Polyvinyl chloride
SDGs	Sustainable development goals
TAC	Total annualized cost
TEA	Techno-economic analysis
TRL	Technology readiness level
UNSDGs	United Nations Sustainable Development Goals



Author contributions

Akeem Mohammed – data curation, formal analysis, investigation, methodology, visualization, writing – original draft, writing – review & editing. Keeran Ward – data curation, formal analysis, investigation, methodology, visualization, funding acquisition, supervision, resources, writing – original draft, writing – review & editing. Koon-Yang Lee – data curation, investigation, methodology, supervision, resources, writing – review & editing. Valerie Dupont – software, writing – review & editing.

Conflicts of interest

There are no conflicts to declare.

Acknowledgements

This work was supported by a University of the West Indies – Trinidad and Tobago Research and Development Impact Fund Innovation Proof of Concept Grant – 26607. The UK's Engineering and Physical Sciences Research Council (EPSRC) is acknowledged for the use of the SimaPro license at The University of Leeds through the two grants EP/L014912/1 (CDT Bioenergy) and EP/T033088/1 (SusLABB).

References

- O. Kehinde, O. J. Ramonu, K. O. Babaremu and L. D. Justin, *Heliyon*, 2020, **6**, e05131.
- P. G. Ryan, in *Marine Anthropogenic Litter*, ed. M. Bergmann, L. Gutow and M. Klages, Springer International Publishing, Cham, 2015, pp. 1–25, DOI: [10.1007/978-3-319-16510-3_1](https://doi.org/10.1007/978-3-319-16510-3_1).
- M. Smith, D. C. Love, C. M. Rochman and R. A. Neff, *Curr. Environ. Health Rep.*, 2018, **5**, 375–386.
- World Economic Forum, *The New Plastics Economy: Rethinking the Future of Plastics*, 2016, <https://www.weforum.org/reports/the-new-plastics-economy-rethinking-the-future-of-plastics/>, (accessed May 2023).
- I. Vanderreydt, T. Rommens, A. Tenhunen, L. Mortensen and I. Tange, *Greenhouse gas emissions and natural capital implications of plastics (including biobased plastics)*, European Topic Centre Waste and Materials in a Green Economy, European Union, 2021.
- V. Batori, D. Åkesson, A. Zamani, M. J. Taherzadeh and I. Sárvári Horváth, *Waste Manage.*, 2018, **80**, 406–413.
- J. W. Roy Chong, X. Tan, K. S. Khoo, H. S. Ng, W. Jonglertjunya, G. Y. Yew and P. L. Show, *Environ. Res.*, 2022, **206**, 112620.
- S. Vardar, B. Demirel and T. T. Onay, *Rev. Environ. Sci. Bio/Technol.*, 2022, **21**, 205–223.
- E. Bioplastics, 2023, <https://www.european-bioplastics.org/market/>, (accessed May 2023).
- D. Ding, L. Gong, M. Li, X. Cheng, H. Peng, Z. Zhang, S. Wang and X. Yan, *Green Chem.*, 2023, **25**, 4004–4012.
- D. G. Oldal, F. Topuz, T. Holtzl and G. Szekely, *ACS Sustainable Chem. Eng.*, 2023, **11**, 994–1005.
- H. Sheng, A. Zhu, L. Zhang, J. Huang, T. Yang, S. Qin, F. Zhang, Q. Xu and H. Xie, *Green Chem.*, 2023, **25**, 3046–3056.
- N. Peelman, P. Ragaert, B. De Meulenaer, D. Adons, R. Peeters, L. Cardon, F. Van Impe and F. Devlieghere, *Trends Food Sci. Technol.*, 2013, **32**, 128–141.
- F. M. Insights, Barrier Packaging Market, <https://www.futuremarketinsights.com/reports/barrier-packaging-market>, (accessed May 2023).
- P. Today, Barrier films market to grow more than 4% annually, <https://www.plasticstoday.com/packaging/barrier-films-market-grow-more-4-annually>, (accessed May 2023).
- N. Rajendran, S. Puppala, M. S. Raj, B. R. Angeeleena and C. Rajam, *J. Pharm. Res.*, 2012, **5**, 1476–1479.
- R. Gade, M. S. Tulasi and V. Bhai, *Int. J. Pharm. Pharm. Sci.*, 2013, **5**, 40–44.
- A. Uribe-Martínez, D. Berriel-Bueno, V. Chávez, E. Cuevas, K. L. Almeida, J. V. H. Fontes, B. I. van Tussenbroek, I. Mariño-Tapia, M. d. I. Á. Liceaga-Correa, E. Ojeda, D. G. Castañeda-Ramírez and R. Silva, *Front. Mar. Sci.*, 2022, **9**, 920339.
- A. Mohammed, R. Bissoon, E. Bajnath, K. Mohammed, T. Lee, M. Bissram, N. John, N. K. Jalsa, K.-Y. Lee and K. Ward, *Carbohydr. Polym.*, 2018, **198**, 109–118.
- A. Mohammed, A. Rivers, D. C. Stuckey and K. Ward, *Carbohydr. Polym.*, 2020, **245**, 116419.
- A. Mohammed, A. Gaduan, P. Chaitram, A. Pooran, K.-Y. Lee and K. Ward, *Food Hydrocolloids*, 2023, **135**, 108192.
- S. Armeli Minicante, L. Bongiorno and A. De Lazzari, *Sustainability*, 2022, **14**, 5634.
- W. Y. Chia, D. Y. Ying Tang, K. S. Khoo, A. N. Kay Lup and K. W. Chew, *Environ. Sci. Ecotechnology*, 2020, **4**, 100065.
- M. A. Zeller, R. Hunt, A. Jones and S. Sharma, *J. Appl. Polym. Sci.*, 2013, **130**, 3263–3275.
- R. E. Rodríguez-Martínez, P. D. Roy, N. Torrescano-Valle, N. Cabanillas-Terán, S. Carrillo-Domínguez, L. Collado-Vides, M. García-Sánchez and B. I. van Tussenbroek, *PeerJ*, 2020, **8**, e8667.
- D. Crutchik, O. Franchi, L. Caminos, D. Jeison, M. Belmonte, A. Pedrouso, A. Val del Rio, A. Mosquera-Corral and J. L. Campos, *Water*, 2020, **12**, 1–12.
- B. Yadav, A. Pandey, L. R. Kumar and R. D. Tyagi, *Bioresour. Technol.*, 2020, **298**, 122584.
- T. H. Kwan, Y. Hu and C. S. K. Lin, *J. Cleaner Prod.*, 2018, **181**, 72–87.
- A. Manandhar and A. Shah, *Processes*, 2020, **8**, 1–14.
- R. Haylock and K. A. Rosentrater, *J. Polym. Environ.*, 2018, **26**, 1484–1503.
- G. H. C. Dubbink, T. R. J. Geverink, B. Haar, H. W. Koets, A. Kumar, H. van den Berg, A. G. J. van der Ham and J.-P. Lange, *Biofuels, Bioprod. Biorefin.*, 2021, **15**, 1021–1030.
- L. Dessbesell, S. Souzanchi, K. T. Venkateswara Rao, A. A. Carrillo, D. Bekker, K. A. Hall, K. M. Lawrence,



- C. L. J. Tait and C. Xu, *Biofuels, Bioprod. Biorefin.*, 2019, **13**, 1234–1245.
- 33 I. Vural Gursel, C. Moretti, L. Hamelin, L. G. Jakobsen, M. M. Steingrimsdottir, M. Junginger, L. Høiby and L. Shen, *Sci. Total Environ.*, 2021, **793**, 148642.
- 34 K. H. Rostkowski, C. S. Criddle and M. D. Lepech, *Environ. Sci. Technol.*, 2012, **46**, 9822–9829.
- 35 S. Belboom and A. Léonard, *Biomass Bioenergy*, 2016, **85**, 159–167.
- 36 P. T. Benavides, U. Lee and O. Zarè-Mehrjerdi, *J. Cleaner Prod.*, 2020, **277**, 124010.
- 37 E. Doyle and J. Franks, *Pelagic Sargassum Influx in the Wider Caribbean*, Gulf and Caribbean Fisheries Institute, 2015.
- 38 University of South Florida, *Outlook of 2022 Sargassum blooms in the Caribbean Sea and Gulf of Mexico*, University of South Florida Optical Oceanography Lab, 2022.
- 39 D. Resiere, R. Valentino, R. Nevière, R. Banydeen, P. Gueye, J. Florentin, A. Cabié, T. Lebrun, B. Mégarbane, G. Guerrier and H. Mehdaoui, *Lancet*, 2018, **392**, 2691.
- 40 K. Langin, *Science*, 2018, **360**, 1157–1158.
- 41 D. Johnson, D. Ko, J. Franks, P. Moreno and G. Sanchez-Rubio, presented in part at the 65th Gulf and Caribbean Fisheries Institute, Colombia, November, 2012.
- 42 B. E. Lapointe, R. A. Brewton, L. W. Herren, M. Wang, C. Hu, D. J. McGillicuddy, S. Lindell, F. J. Hernandez and P. L. Morton, *Nat. Commun.*, 2021, **12**, 3060.
- 43 D. Indar, *National energy efficiency monitoring report of Trinidad and Tobago, Economic Commission for Latin America and the Caribbean (ECLAC)*, 2019.
- 44 S. Millette, E. Williams and C. E. Hull, *Resour., Conserv. Recycl.*, 2019, **150**, 104436.
- 45 Government of the Republic of Trinidad and Tobago, *National Waste Recycling Policy*, 2015.
- 46 CBCL, *Trinidad solid waste management program waste characterization and centroid study final report*, Ministry of Local Government, 2010.
- 47 A. I. Y. Tok, F. Y. C. Boey and M. K. A. Khor, *J. Mater. Eng. Perform.*, 1999, **8**, 469–472.
- 48 S. Szepessy and P. Thorwid, *Chem. Eng. Technol.*, 2018, **41**, 2375–2384.
- 49 P. K. Sappati, B. Nayak and G. P. VanWalsum, *Int. J. Food Prop.*, 2019, **22**, 1966–1984.
- 50 A. Wortel, W. Huijgen and J. Van Hal, *Storing and Refining Seaweed*, 2014.
- 51 J. R. Moss and M. Doty, *Establishing a Seaweed Industry in Hawaii: An Initial Assessment*, Aquaculture Development Program of the Hawaii State Department of Land and Natural Resources Hawaii, 1987.
- 52 V. C. E. Le Gloahec, *Fixation of Chlorophyllian Colored Matter*, 1939.
- 53 W. Amos, *Report on Biomass Drying Technology*, United States, National Renewable Energy Lab (NREL), 1999.
- 54 N. Hussein, H. Omer, A. Ismael, M. A. Alhnan, A. Elhissi and W. Ahmed, *Pharm. Dev. Technol.*, 2020, **25**, 290–299.
- 55 X. Sun, R. G. Cameron and J. Bai, *Food Hydrocolloids*, 2020, **100**, 105420.
- 56 H. R. Campbell, F. M. Alsharif, P. J. Marsac and R. A. Lodder, *J. Pharm. Innovation*, 2022, **17**, 194–206.
- 57 S. A. Strobel, L. Knowles, N. Nitin, H. B. Scher and T. Jeoh, *J. Food Eng.*, 2020, **266**, 109695.
- 58 J. O. de Moraes, A. S. Scheibe, A. Sereno and J. B. Laurindo, *J. Food Eng.*, 2013, **119**, 800–808.
- 59 C. M. Ortiz, J. O. de Moraes, A. R. Vicente, J. B. Laurindo and A. N. Mauri, *Food Hydrocolloids*, 2017, **66**, 110–117.
- 60 International Organization for Standardization, *ISO 14040:2006 c2006 Environmental management, Life Cycle Assessment-Principles and Framework*, Geneva, 2006.
- 61 S. A. Ashter, in *Introduction to Bioplastics Engineering*, ed. S. A. Ashter, William Andrew Publishing, Oxford, 2016, pp. 227–249, DOI: [10.1016/B978-0-323-39396-6.00009-9](https://doi.org/10.1016/B978-0-323-39396-6.00009-9).
- 62 H. Karan, C. Funk, M. Grabert, M. Oey and B. Hankamer, *Trends Plant Sci.*, 2019, **24**, 237–249.
- 63 M. Zabihzadeh Khajavi, A. Ebrahimi, M. Yousefi, S. Ahmadi, M. Farhoodi, A. Mirza Alizadeh and M. Taslikh, *Food Eng. Rev.*, 2020, **12**, 346–363.
- 64 Omnexus, Density of Plastics: Technical Properties, <https://omnexus.specialchem.com/polymer-properties/properties/density>, (accessed November 11 2022).
- 65 M. Hery, S. Evangelisti, P. Lettieri and K.-Y. Lee, *Compos. Sci. Technol.*, 2015, **118**, 154–162.
- 66 C. Jaggai, Z. Imkaraaz, K. Samm, A. Pounder, N. Koylass, D. P. Chakrabarti, M. Guo and K. Ward, *Green Chem.*, 2020, **22**, 4279–4294.
- 67 N. Samaroo, N. Koylass, M. Guo and K. Ward, *Green Chem.*, 2020, **22**, 6547–6559.
- 68 L. T. Bach, V. Tamsitt, J. Gower, C. L. Hurd, J. A. Raven and P. W. Boyd, *Nat. Commun.*, 2021, **12**, 2556.
- 69 A. Desrochers, S. Cox, H. A. Oxenford and B. van Tussenbroek, *Sargassum Uses Guide: A Resource for Caribbean Researchers, Entrepreneurs and Policy Makers*, CERMES, 2020.
- 70 Safety4Sea, Trinidad and Tobago aims to be methanol hub for ships, <https://safety4sea.com/trinidad-and-tobago-aims-to-be-methanol-hub-for-ships/>, (accessed December 2022).
- 71 N. C. Marzolf, F. Casado Cañeque, J. Klein and D. Loy, *A unique approach for sustainable energy in Trinidad and Tobago*, Inter-American Development Bank, 2015.
- 72 Predator Oil & Gas Holdings Plc, Inniss Trinity oil field well participation agreement, <https://www.predatoroiland-gas.com/operations/trinidad/#C02-Supply-Contract>, (accessed January 2023).
- 73 R. Itiki, M. Manjrekar, S. G. Di Santo and C. Itiki, *Renewable Sustainable Energy Rev.*, 2023, **173**, 113082.
- 74 International Renewable Energy Agency (IRENA), *Energy profile: Trinidad and Tobago*, 2019, https://www.irena.org/-/media/Files/IRENA/Agency/Statistics/Statistical_Profiles/Central%20America%20and%20the%20Caribbean/Trinidad%20and%20Tobago_Central%20America%20and%20the%20Caribbean_RE_SP.pdf, (accessed May 2023).
- 75 J. Mahabir, N. Koylass, N. Samaroo, K. Narine and K. Ward, *Energy Convers. Manage.*, 2021, **233**, 113930.



- 76 R. Turton, J. Shaeiwitz, D. Bhattacharyya and W. Whiting, in *Analysis, Synthesis, and Design of Chemical Processes*, Prentice Hall, Boston, 5th edn, 2018, ch. 7.
- 77 S. Michailos, D. Parker and C. Webb, *Chem. Eng. Res. Des.*, 2017, **118**, 206–214.
- 78 K. Bhagaloo, A. Baboolal, R. Ali, Z. Razac, A. Lutchmansingh, A. Mangra, T. Muhammad and K. Ward, *Chem. Eng. Res. Des.*, 2022, **178**, 405–420.
- 79 G. Towler and R. Sinnott, in *Chemical Engineering Design*, ed. G. Towler and R. Sinnott, Butterworth-Heinemann, Boston, 2nd edn, 2013, ch. 7, pp. 307–396, DOI: [10.1016/B978-0-08-096659-5.00007-9](https://doi.org/10.1016/B978-0-08-096659-5.00007-9).
- 80 S. Jenkins, Chemical Engineering Plant Cost Index Annual Average 2019, <https://www.chemengonline.com/2019-chemical-engineering-plant-cost-index-annual-average/>, (accessed July 2021).
- 81 Independent Commodity Intelligence Services, US 2019 Soda Ash Prices Increase Amid Global Short Supply, <https://www.icis.com/explore/resources/news/2019/01/15/10306648/us-2019-soda-ash-prices-increase-amid-globally-short-supply/>, (accessed July 2021).
- 82 Methanex, Methanex Monthly Average Regional Posted Contract Price History, <https://www.methanex.com/sites/default/files/MxAvgPrice%20June%2030%202021.pdf>, (accessed July 2021).
- 83 Echemi, Formaldehyde China Domestic Price https://www.echemi.com/productsInformation/pid_Seven5-formaldehyde.html, (accessed July 12th 2021).
- 84 Echemi, Sodium Hypochlorite China Domestic Price, https://www.echemi.com/productsInformation/pid_Rock19677-sodiumhypochlorite.html, (accessed July 2021).
- 85 Global Trade, Germany's Production of Potato Starch is Continously Decreasing due to Exports Contraction, <https://www.globaltrademag.com/germanys-production-of-potato-starch-is-continuously-decreasing-due-to-exports-contraction/>, (accessed July 22nd 2021).
- 86 Independent Commodity Intelligence Services, Chemical Prices, <https://www.icis.com/explore/resources/news/2004/03/04/560887/chemical-prices/>, (accessed July 2021).
- 87 Independent Commodity Intelligence Services, Chemical Profile: Sorbitol, <https://www.icis.com/explore/resources/news/2007/12/17/9086749/chemical-profile-sorbitol/>, (accessed July 2021).
- 88 Abrams, Polyoxyethylene (Polyethylene Glycol) Waxes, <https://en.abrams.wiki/hscodex/340420>, (2021).
- 89 Independent Commodity Intelligence Services, Chemical Profile: Calcium Chloride, <https://www.icis.com/explore/resources/news/2008/06/16/9132398/chemical-profile-calcium-chloride/>, (accessed July 2021).
- 90 Trinidad and Tobago Electricity Commission, Summary of Electricity Rates, <https://ttec.co.tt/default/wp-content/uploads/2015/08/Tariffs.pdf>, (accessed July 15th 2021).
- 91 Ultrafiltration system in Trinidad and Tobago, <https://www.vikaspumps.com/trinidad-and-tobago/ultrafiltration-system.html>, (accessed May 2023).
- 92 ACCIONA, ACCIONA starts construction work on its first wastewater treatment plant in Trinidad & Tobago, https://www.acciona.com/updates/news/acciona-starts-construction-work-first-wastewater-treatment-plant-trinidad-tobago/?_adin=02021864894 (accessed December 2022).
- 93 K. Narine, J. Mahabir, N. Koylass, N. Samaroo, S. Singh-Gryzbon, A. Baboolal, M. Guo and K. Ward, *J. CO2 Util.*, 2021, **44**, 101399.
- 94 K. J. Jem and B. Tan, *Adv. Ind. Eng. Polym. Res.*, 2020, **3**, 60–70.
- 95 Alibaba, Sodium Alginate, https://www.alibaba.com/product-detail/Sodium-Alginate-Sodium-Alginate-LANNERET-SODIUM_60738944312.html?spm=a2700.galleryofferlist.topad_creative.d_title.66d465f0ga1835, (accessed July 2021).
- 96 D. Purcell-Meyerink, M. A. Packer, T. T. Wheeler and M. Hayes, *Molecules*, 2021, **26**, 1–41.
- 97 M. Van den Oever, K. Molenveld, M. Zee and H. Bos, *Bio-Based and Biodegradable Plastics – Facts and Figures*, Wageningen Food & Biobased Research, Wageningen, 2017.
- 98 J. C. Philp, A. Bartsev, R. J. Ritchie, M.-A. Baucher and K. Guy, *New Biotechnol.*, 2013, **30**, 635–646.
- 99 International Renewable Energy Agency (IRENA) and Methanol Institute, *Innovation Outlook: Renewable Methanol*, Abu Dhabi, 2021.
- 100 M. León, J. Silva, S. Carrasco and N. Barrientos, *Processes*, 2020, **8**, 1–14.
- 101 J. Brizga, K. Hubacek and K. Feng, *One Earth*, 2020, **3**, 45–53.
- 102 H. Bakhtiary-Davijany and T. Myhrvold, *Energy Procedia*, 2013, **37**, 2579–2584.
- 103 L. Miller, K. Soulliere, S. Sawyer-Beaulieu, S. Tseng and E. Tam, *Materials*, 2014, **7**, 5883–5902.
- 104 S. Rameshkumar, P. Shaiju, K. E. O'Connor and P. Ramesh Babu, *Curr. Opin. Green Sustain. Chem.*, 2020, **21**, 75–81.
- 105 M. Esposti, D. Morselli, F. Fava, L. Bertin, F. Cavani, D. Viaggi and P. Fabbri, *FEBS Open Bio*, 2021, **11**, 967–983.
- 106 United Nations, *The Sustainable Development Goals Report*, 2020.
- 107 Organisation for Economic Co-operation and Development, *OECD Science, Technology and Industry Policy Papers No. 10*, 2013, DOI: [10.1787/5k3xpf9rrw6d-en](https://doi.org/10.1787/5k3xpf9rrw6d-en).
- 108 GOV.UK, Introduction of plastic packaging tax from April 2022, <https://www.gov.uk/government/publications/introduction-of-plastic-packaging-tax-from-april-2022/introduction-of-plastic-packaging-tax-2021> (accessed December 2021).
- 109 T. D. Moshood, G. Nawanir, F. Mahmud, F. Mohamad, M. H. Ahmad and A. Abdul Ghani, *Sustainability*, 2021, **13**, 1–13.
- 110 W. L. Filho, A. L. Salvia, A. Bonoli, U. A. Saari, V. Voronova, M. Klôga, S. S. Kumbhar, K. Olszewski, D. M. De Quevedo and J. Barbir, *Sci. Total Environ.*, 2021, **755**, 142732.

